

# 9010P

900×900×2100mm

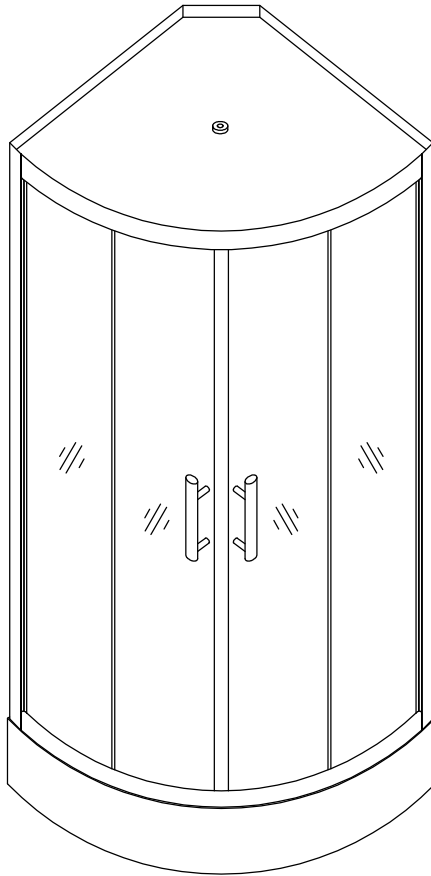

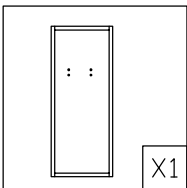

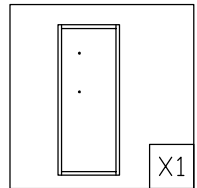
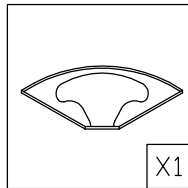
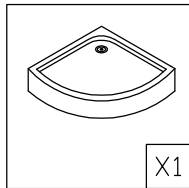
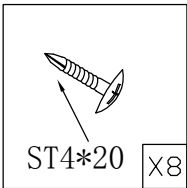
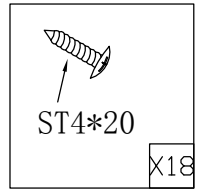
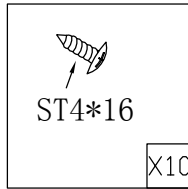
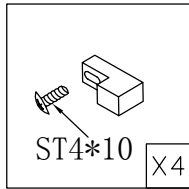
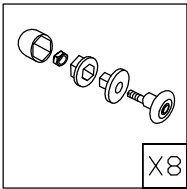
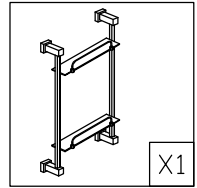
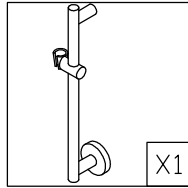
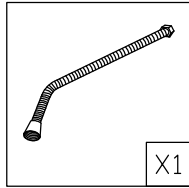
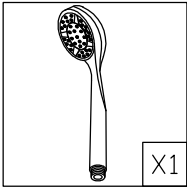
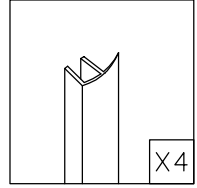
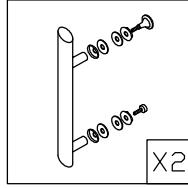
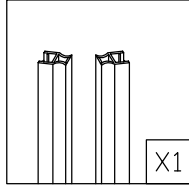
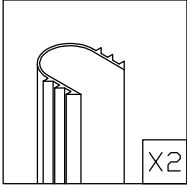
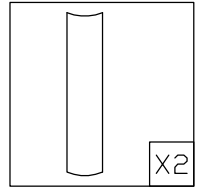
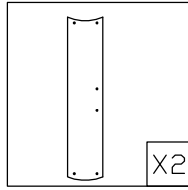
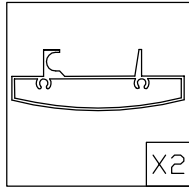
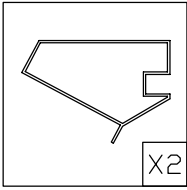
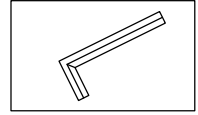
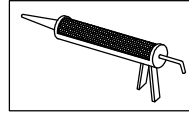
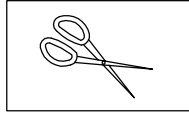
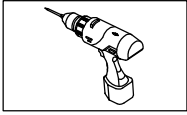
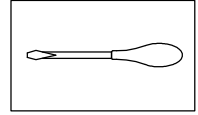
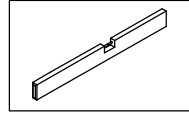
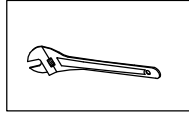
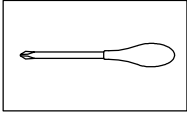

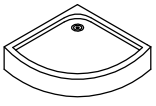

X1

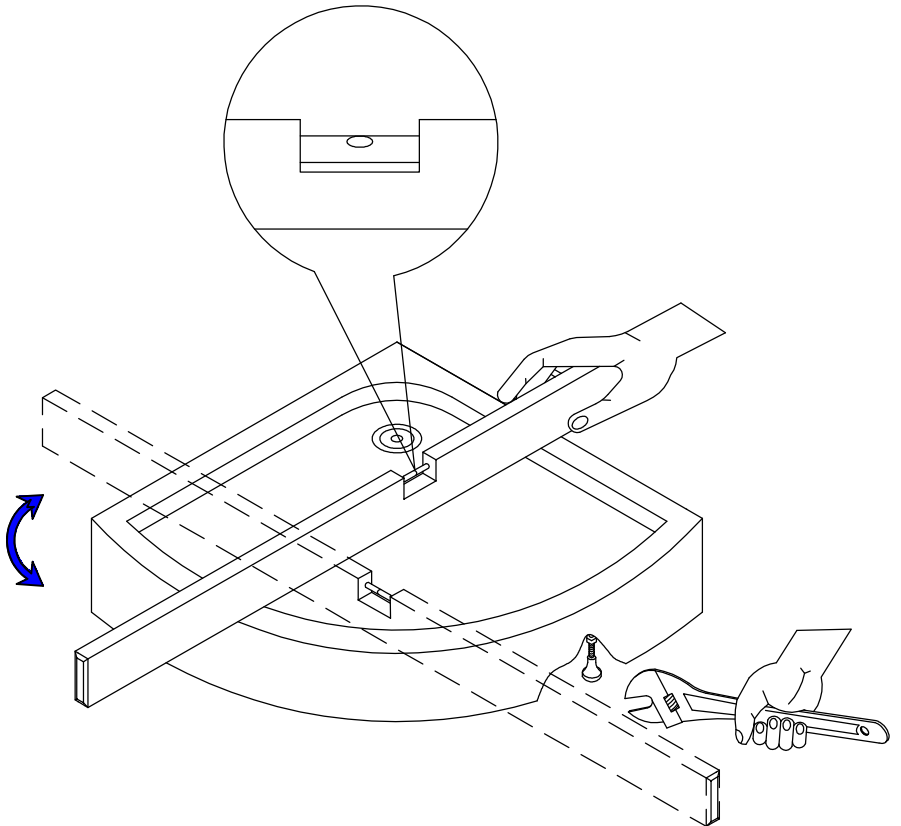
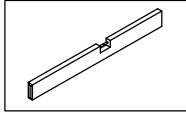
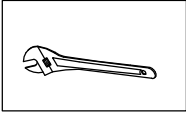

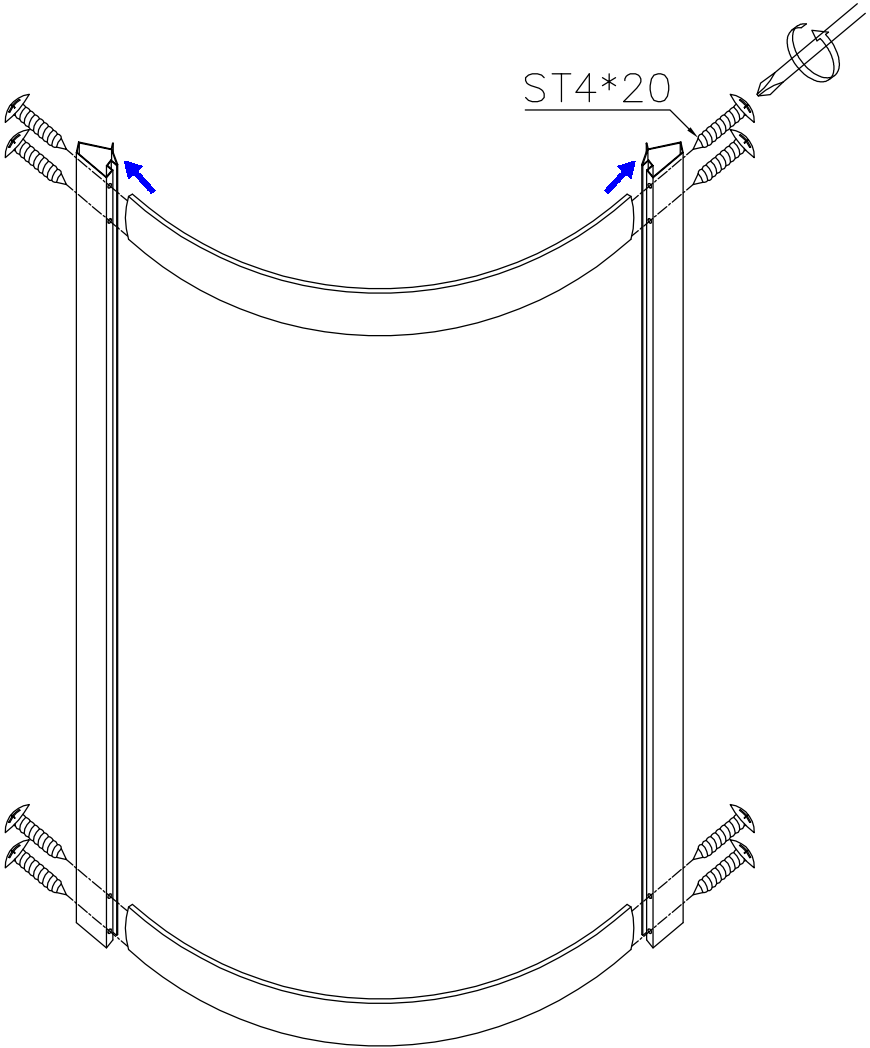
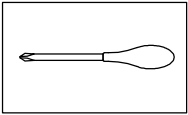
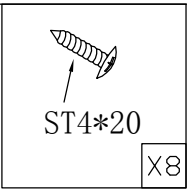
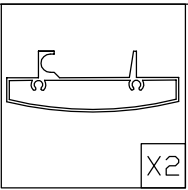
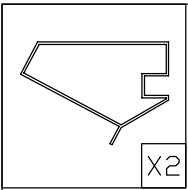

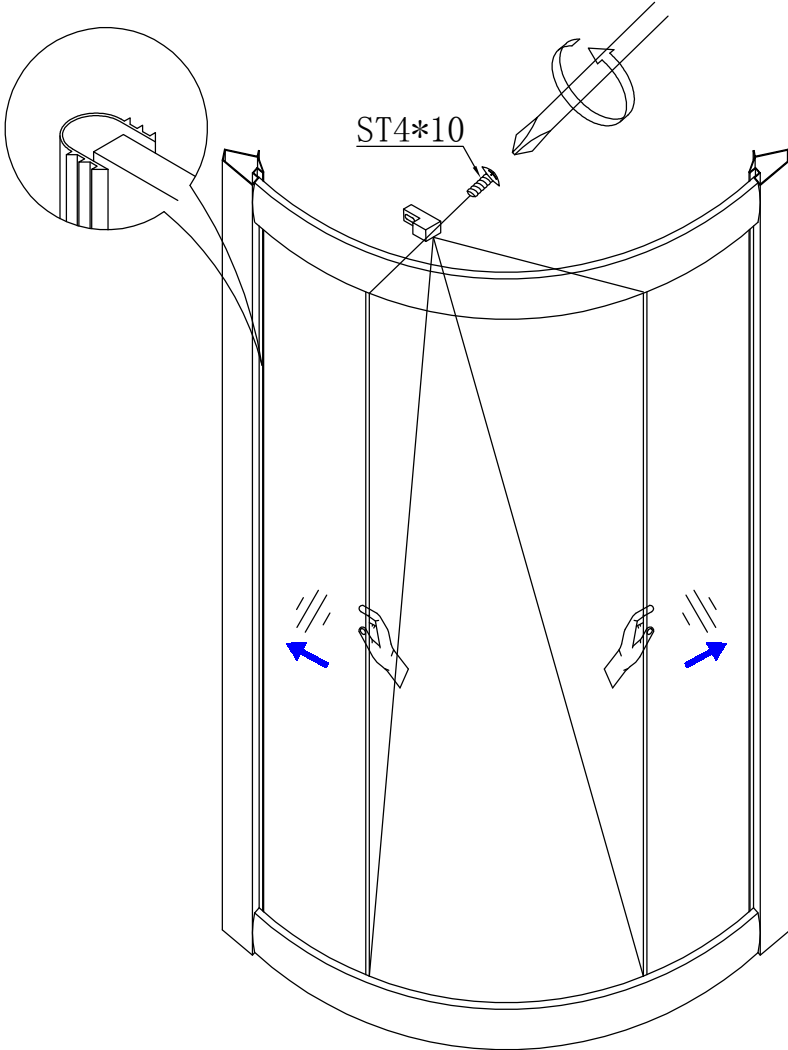
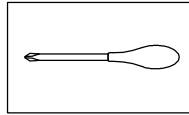
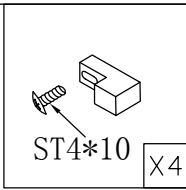
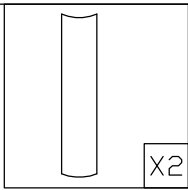
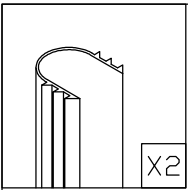

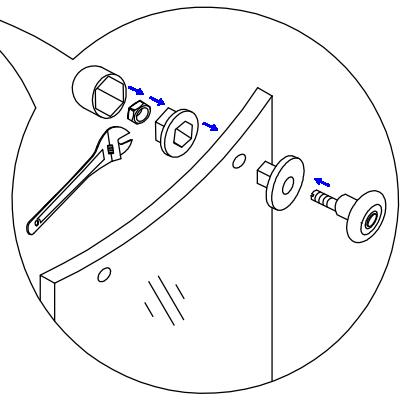
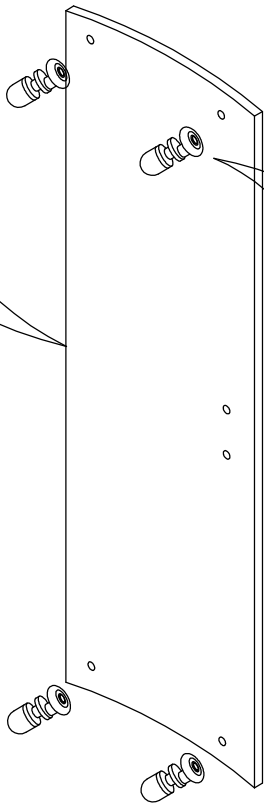
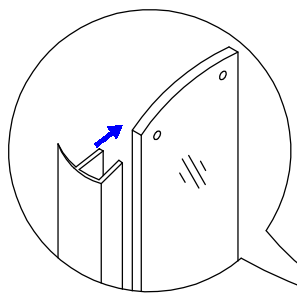
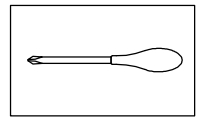
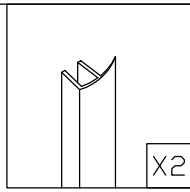
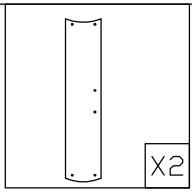
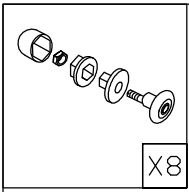

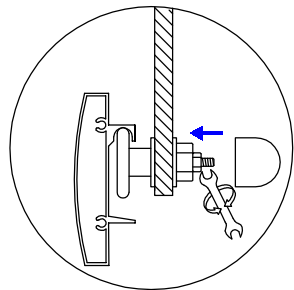
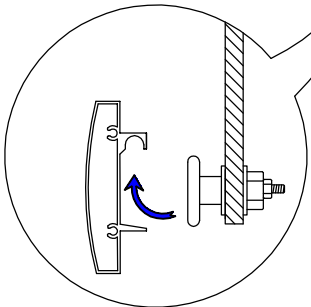
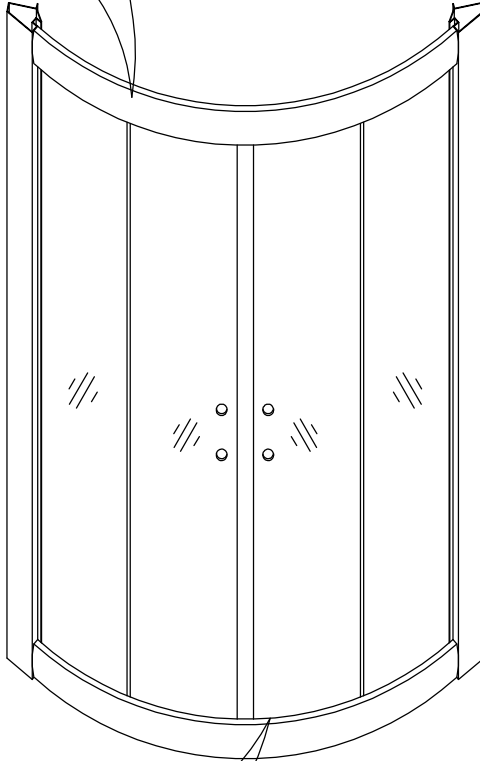
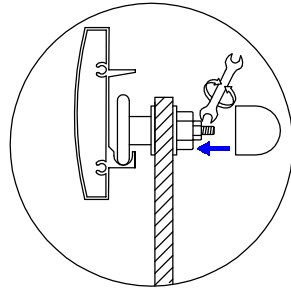
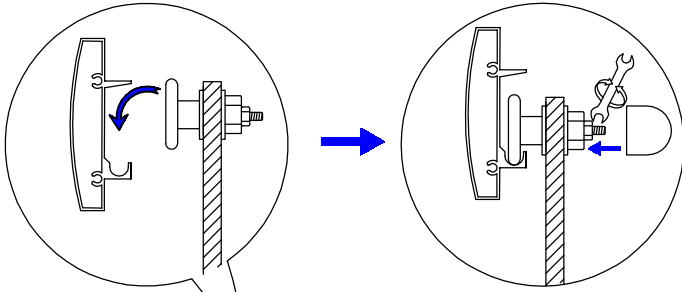



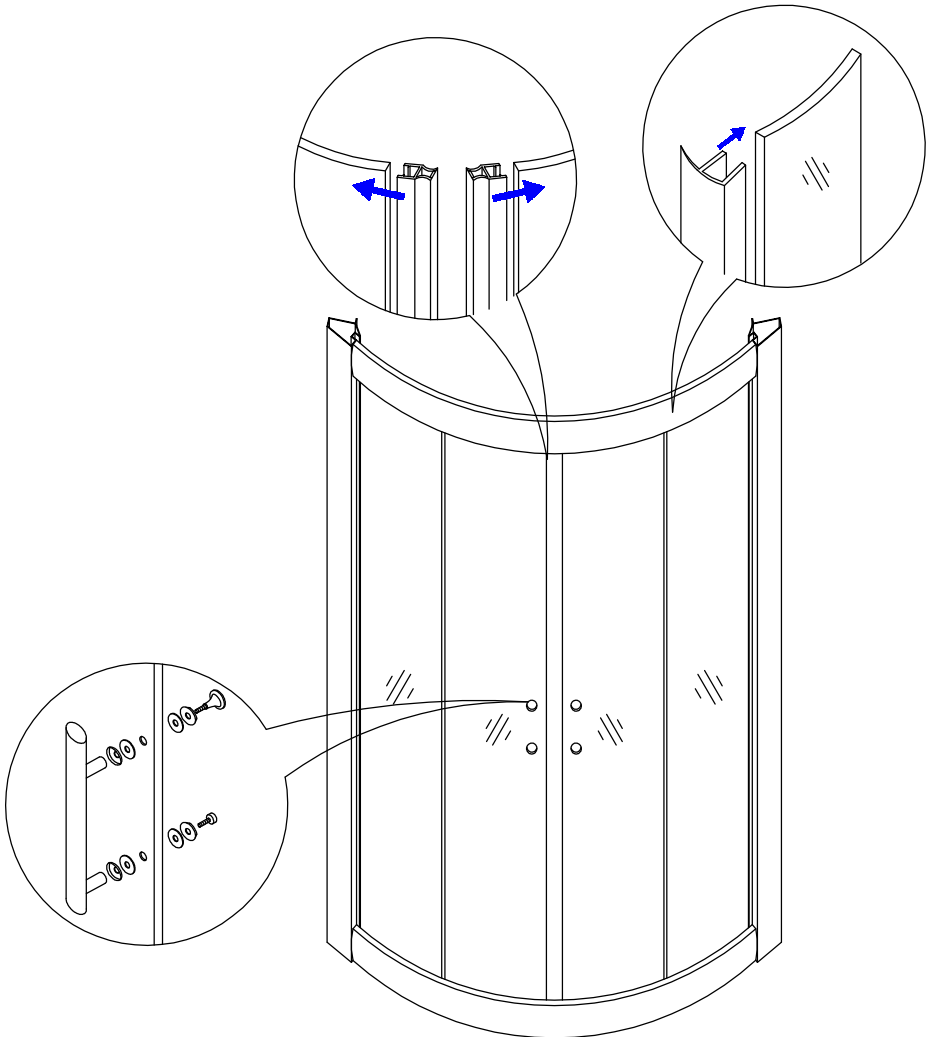
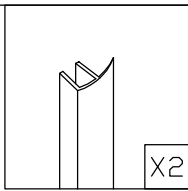
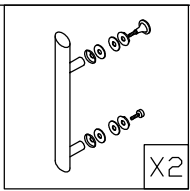
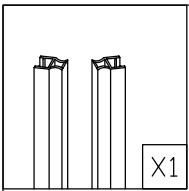

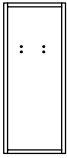

X1

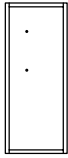

X1



ST4\*16

X10

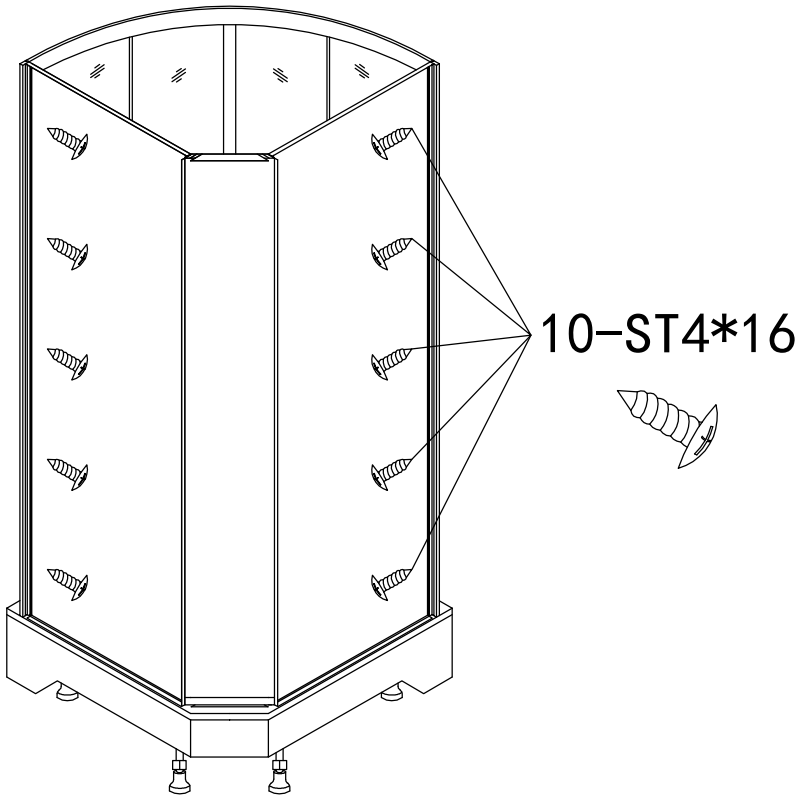
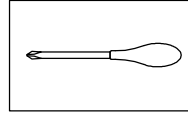



ST4\*20

X10

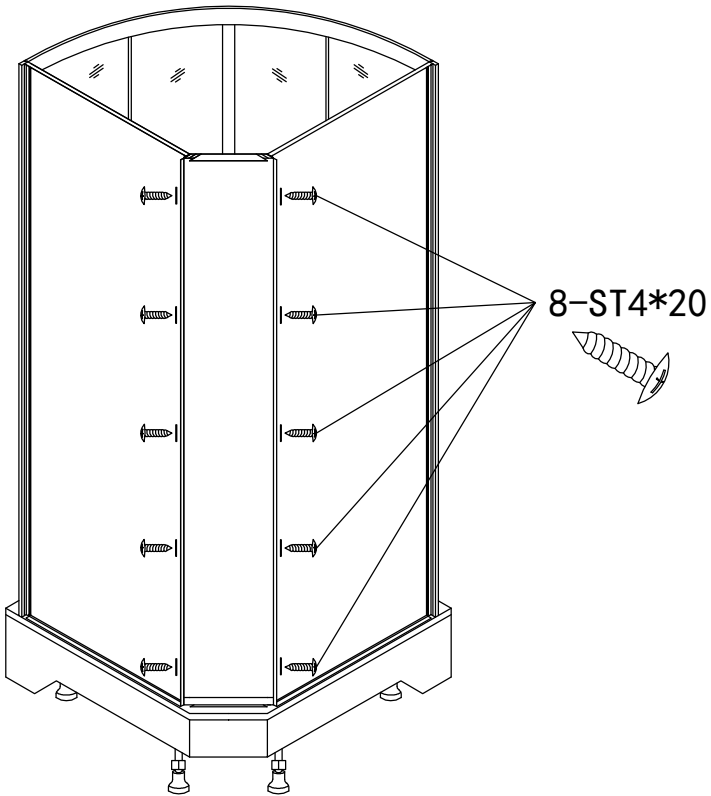
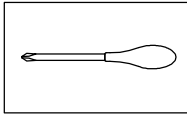

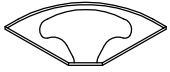

X1



ST4\*20

X8

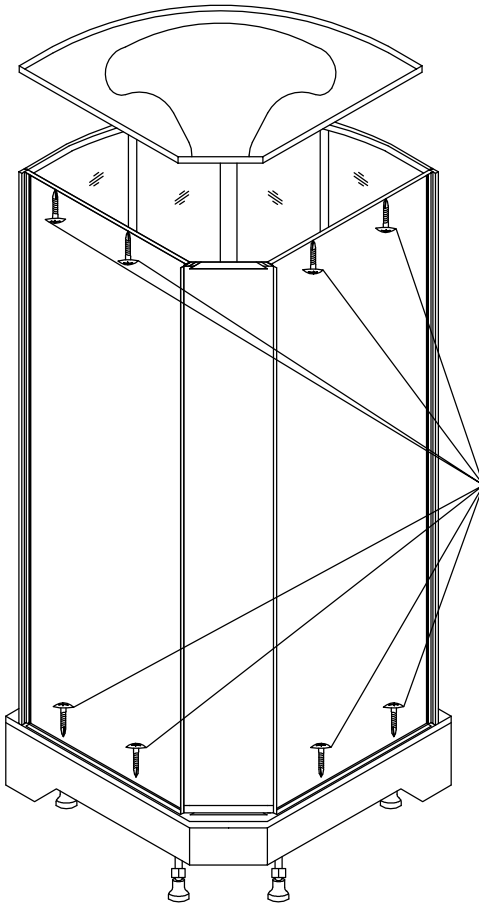
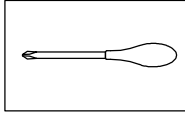

4-ST4\*20



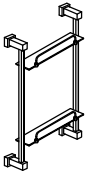

X1

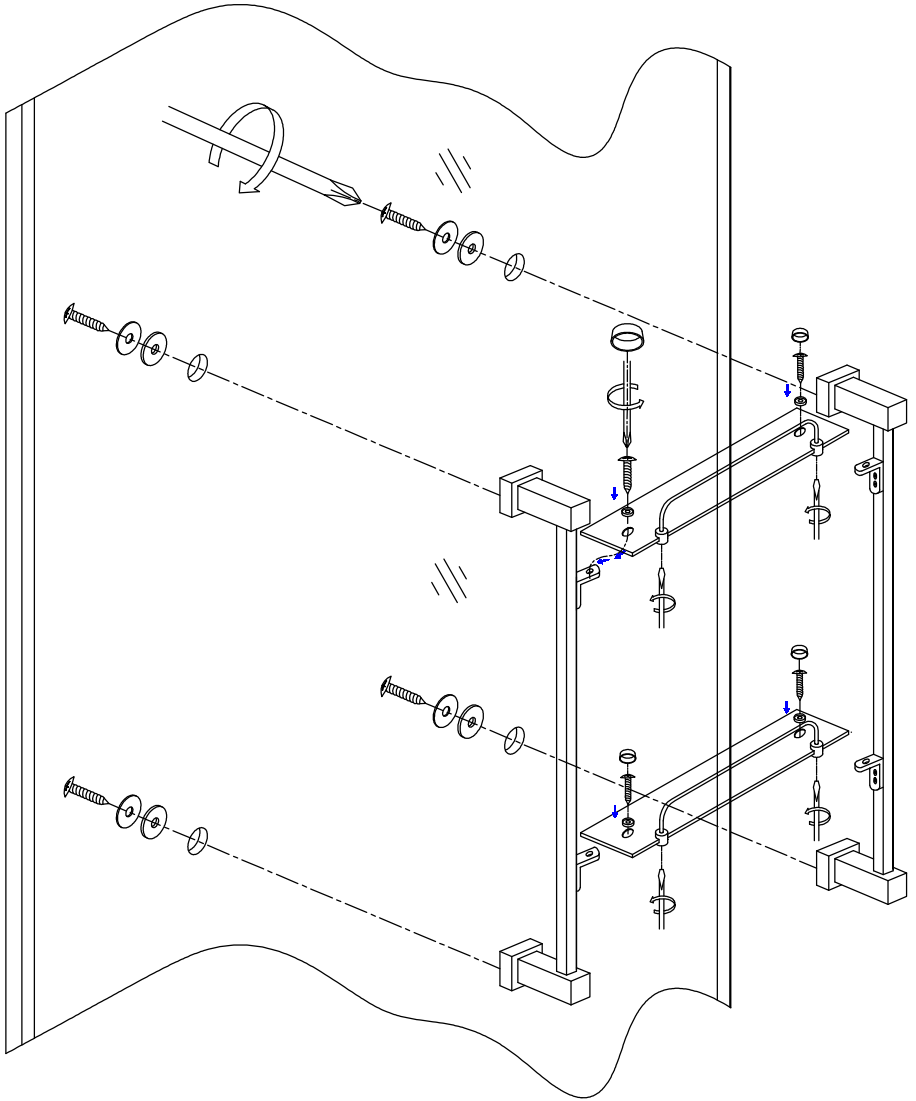
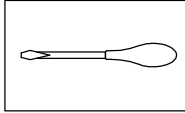
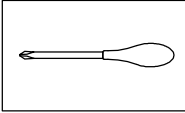



X1

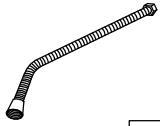

X1

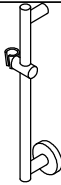

X1

