

## 1 GENERAL SYSTEM INFORMATION

This device is part of the Innovega® room heating solution and communicates via its own radio protocol. It can be comfortably and individually controlled via a wireless thermostat. The functional scope of the system in combination with other components can be found in the respective user manual.

### Scope of delivery

Amount	description
1	switch box
1	user manual



Documentation © Innovega GmbH, Austria

All rights reserved. No part of this manual may be reproduced in any form or duplicated or processed by electronic, mechanical or chemical means without written permission of the publisher.

Corrections are reserved by the manufacturer. We accept no liability for errors of technical or typographical nature and their consequences.

All trademarks and copyrights are reserved.  
Changes in the sense of technical progress can be made without prior notice.

Version 1.0





## CONTENTS

1 General System Information	1
2 Instructions for use	4
3 Warnings	5
4 Function and device overview	8
5 First use	10
5.1 Mounting	10
5.2 Connecting box and thermostat	10
5.3 Disconnecting box and thermostat	11
6 Operating Modes and Configuration	12
7 Troubleshooting	13
8 Maintenance and cleaning	15
9 General information on radio operation	16
9.1 Duty Cycle	17
10 Technical data	18
Disposal note	19
Declaration of Conformity	19
11 Compatibility	20

## 2 INSTRUCTIONS FOR USE

Read these instructions carefully before using your Innovega® devices.  
Keep the instructions for future reference!  
If the device is used by others, please hand over this manual as well.

### Used symbols











**Attention!**  
This indicates a danger.







**Note:** This section contains additional important information!

### 3 HAZARD NOTICE

	Do not open the device. It contains no user-serviceable parts. If a fault occurs, have the device checked by a specialist.
	Do not use the device if external damage is visible, e.g. on the housing, on control elements or on the connection sockets or a malfunction. If in doubt, have the device checked by a specialist. For reasons of safety and approval (CE), the unauthorized conversion and / or modification of the device is not permitted.
	Operate the device indoors only and do not expose it to moisture, vibration, constant solar or other heat radiation, excessive cold and no mechanical stress.
	The device is not a toy! Do not allow children to play with it. Do not leave the packaging material careless. Plastic films / bags, Styrofoam parts etc. can be dangerous for children.

	In case of property damage or personal injury caused by improper handling or non-observance of the hazard warnings, we assume no liability. In such cases, any warranty claim expires! For further damages we do not accept liability!
	Before connecting a load, observe the technical data, in particular the maximum permissible switching capacity of the relay and the type of load to be connected! All load data refer to ohmic loads! Only load the device up to the specified power limit. An overload can lead to the destruction of the device, to a fire or electric accident.
	The device may only be connected to an easily accessible mains socket. In the event of danger, remove the device from the mains socket.
	Always remove the plug of connected appliances from the switch socket before making any changes to the load.
	Always lay the cables in such a way that they can not endanger people or pets.

	The device is not suitable for unlocking. The load is not galvanically isolated from the mains.
	Only clean the device after removing it from the socket with a dry cloth that can be slightly moistened in case of heavy soiling. Do not use solvent-based cleaning agents for cleaning. Make sure that no liquid gets inside the unit.
	Any other use than that described in this manual is not intended and leads to warranty and disclaimer. This also applies to conversions and changes.
	Adapter devices must not be plugged in one behind the other.
	The device is only suitable for use with Innovega® heating systems in apartment-like environments.





## 4 FUNCTION AND DEVICE OVERVIEW

With the switch socket you can switch your connected infrared heater in conjunction with a suitable thermostat temperature controlled on and off and adapt it to your individual needs.

The switch socket can be mounted quickly and without tools after plugging into the socket, the device can be immediately connected to the thermostat.

Thanks to the compact design, no surrounding sockets are blocked.







**Device overview top view:**

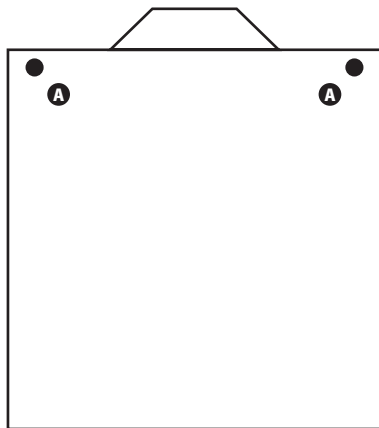

**A** Screwholes





**Device overview rear view:**

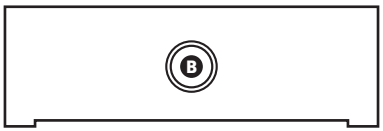

**B** System button

10





**Device overview front view:**

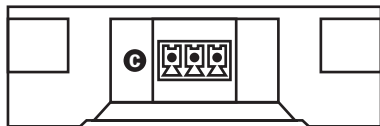

**C** Connection plug



## 5 FIRST USE

### 5.1. Assembly

In order for the switch box to control the heater, it must be connected to the heater. Firstly remove the „bridge“ on the rear of the heater and replace it with the switch box. To do this the two screws **1** must be removed on the top side. Pull the bridge **D** off **2**.

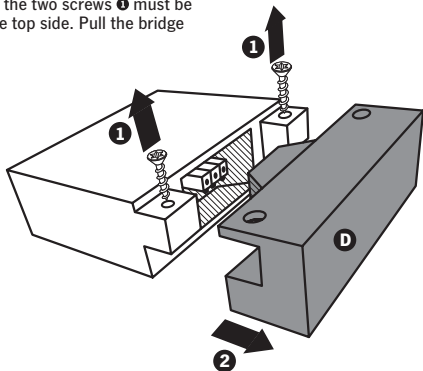

Insert the switch box **E** in place of the bridge into the connection shaft **1** and affix with the original screws **2**. Now the heater can be connected to the power supply. The flashing yellow system button indicates connection mode and correct assembly.

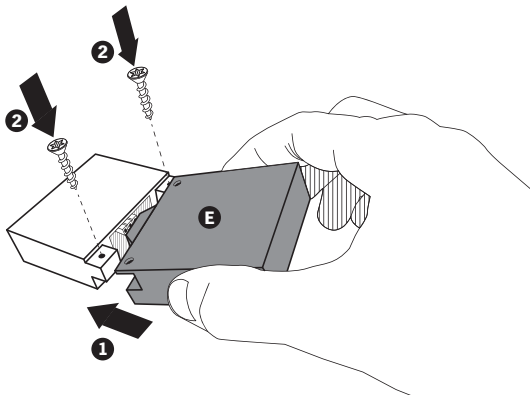



When plugged in for the first time, the switch box is automatically in connection mode.

## 5.2. Connecting switch box and thermostat



Please read this section completely before starting to connect.

If you want to connect the switch box to a thermostat, proceed as follows:

- Bring the thermostat as close as possible (5 to 15 cm) to the inserted, ready-to-connect switch box (system button flashes yellow).
- Press the link-up button on the back of the thermostat and stay as close as possible to the plug-in switch socket (5 to 15 cm). Details can be found in the operating instructions of the thermostat.
- The link-up process is started. The system key flashes yellow during the link-up process.

Successful link-up is confirmed by a steady light (red or green) of the system button on the switch socket.

### 5.3. Disconnecting switch socket and thermostat

To delete the switch socket from the thermostat, proceed as follows:

- Press and hold the system button of the switch socket for 3 seconds.
- To confirm disconnection from the thermostat, the system button will start to flash yellow again. The switch socket is now in connection mode again.



By disconnecting from the thermostat, it will issue a connection error at the next connection. For further information please refer to the operating instructions for the thermostat.

## 6 OPERATING MODES AND CONFIGURATION

After plugging the heater into a mains socket and successfully connecting to a thermostat, the switch socket is ready for use. The respective operating status can be quickly recognized by the color of the illuminated system key:



If the system button is solid red, no current flows through the switch box. The connected heater is switched off, it does not heat.

If the system button is solid green, power will flow through the switch box. The connected heater is switched on, it heats.

With a short press on the system key you can switch off the illumination of the system key. This may be recommended in bedrooms or children's rooms where lighting may be perceived as too bright and therefore annoying.



A short press of the system button turns off only the red or green light of the system button. This has no effect on the control of the connected loads. Error messages (yellow steady light) and the connection mode (yellow flashing) are still displayed.





## 7 TROUBLESHOOTING

If a connection error occurs during operation, the system button lights up yellow. The thermostat may also give an error message. Details can be found in the operating instructions of the thermostat.

The faulty transmission can have the following causes:

- Thermostat out of reach,
- batteries of the thermostat are weak,
- Thermostat defective or
- Switch box defective.



In this case, as a precaution, replace the batteries of the thermostat and check the thermostat for accessibility. Change the temperature on the thermostat to send an on or off signal to the switch socket. If the problem persists, disconnect the switch box from the thermostat and reconnect it.



### 7.1. Error codes and blinking sequences

Flashing sequences are indicated by the LED in the system button on the front of the switch socket.

Flashing sequence	Meaning	Solution
System button flashes yellow	Connection mode is active.	Connect the switch socket to a thermostat.
System-button flashes yellow – doesn't connect	Connection error	Unplug the heater from the the power supply. Wait 10 seconds then reconnect the heater with the thermostat according to the instructions.
System button lights up red.	If the system button is solid red, no current flows through it the switch socket. The connected heating is switched off, it is not heated.	

Flashing sequence	Meaning	Solution
System button lights up green	If the system button is solid green, power will flow through the system Switch socket. The connected heater is switched on, it heats.	
LED is solid yellow	Connection error with thermostat.	Change the temperature on the thermostat to send an on or off signal to the switch socket. If the problem persists, disconnect the switch socket from the thermostat and reconnect it.

## 8 MAINTENANCE AND CLEANING



The device is maintenance-free. Leave maintenance or repair to a specialist.

Clean the device with a soft, clean, dry, lint-free cloth. To remove excess dirt, wipe the cloth lightly with lukewarm water. Do not use solvent-based cleaning agents, as this can damage the plastic housing and the lettering.

## 9 GENERAL INFORMATION ON RADIO OPERATION

The radio transmission is realized on a non-exclusive transmission path, which is why disturbances can not be ruled out. Further disturbances can be caused by switching operations, electric motors or defective electrical appliances.



The range in buildings can vary greatly from that in the open field. In addition to the transmission power and the reception characteristics of the receivers, environmental factors such as humidity play an important role in addition to structural conditions on site.



## 9.1. Duty Cycle

The duty cycle describes a legally regulated limitation of the transmission time of devices in the 868 MHz range. The aim of this scheme is to ensure the operation of all devices operating in the 868 MHz range. In this frequency range, the maximum transmission time of each device is 1% of an hour (ie 36 seconds in one hour). In normal operation, the duty cycle is usually not achieved. However, this may be the case in individual cases during initial installation of a system by increased and intensive connecting processes.

Innovega® GmbH hereby declares that this device complies with the basic requirements and other relevant provisions of Directive 1999/5 / EC.



## 10 TECHNICAL DATA

Device short name: ..... Maria Box  
Supply voltage: ..... 230 V / 50 Hz  
Power consumption: ..... 16 mA max.  
Power consumption Sleep mode: ..... < 0,2 W  
Max. Switching capacity: ..... 3680 W  
Life expectancy relay / switching cycles: ..... 400000 (16A ohmic load)  
Relay: ..... NO, 1-pole,  $\mu$ -contact  
Switch type: ..... independently mounted counter  
Operating mode ..... S1  
Impulse strength: ..... 2500 V  
Protection class: ..... I  
Type of protection: ..... IP20  
Ambient temperature: ..... -10 bis 40 °C  
Dimensions (W x H x D): ..... 68 x 67 x 28 mm (without mains plug)

22

Mass: ..... 113 g  
Radio frequency: ..... 867,2 MHz  
Recipient category: .....SRD  
Type. Radio Free Field Range: ..... 400 m  
Duty Cycle: ..... < 1 % pro h/< 10 % pro h  
Mode of action: ..... Typ 1  
Pollution degree: ..... 2  
Reserve technical changes.

#### **disposal notes**



Do not dispose of this device through domestic waste. Electronic equipment must be disposed of in accordance with the WEEE Directive through local WEEE collection centers.

#### **compliance Notice**



The CE mark is a free trade mark exclusively for the authorities



For technical questions about the device, please contact your dealer.

## 11 COMPATIBILITY

The switch socket „Maria“ is compatible with the following thermostats:  
Thermostat „Deus“