

INSTRUCTION MANUAL

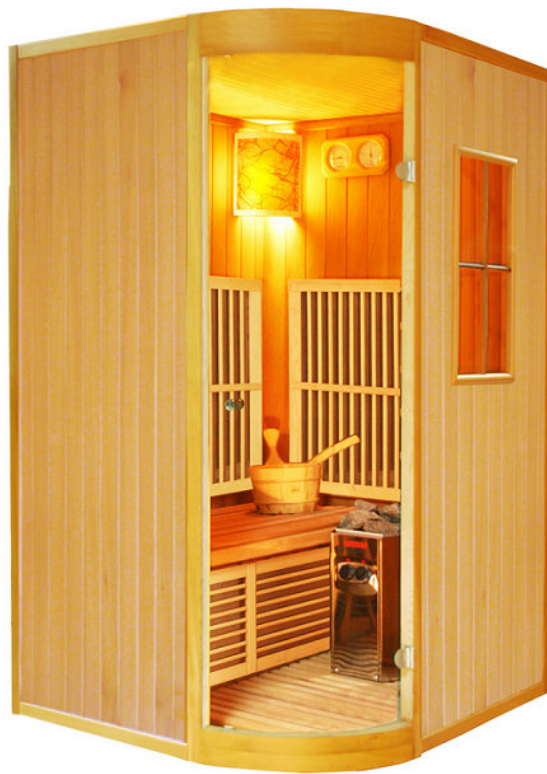

NYS-2A3

Index

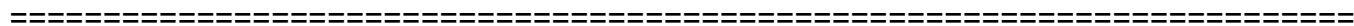

Important safety guides.....	2
Installation.....	3
Installation Steps.....	4-7
Operation.....	8-9
Trouble Shooting	9-10
Transportation& Store.....	11
Packing List.....	11

IMPORTANT SAFETY GUIDES

READ AND FOLLOW ALL INSTRUCTIONS

- A) Extending Socket or other electric appliance is forbidden to be used inside the cabin.
- B) Any lock or latch system must not be fixed to the door of the sauna room, malfunction of which may cause entrapment inside the sauna room.
- C) Open the ventilation window if you feel choking when using sauna room
- D) Don't use infrared sauna when you are hyperthermia.
 - **The occurrence of hyperthermia:** Hyperthermia occurs when the internal temperature of the body reaches a level several degrees above the normal body temperature of 98.6°F (37°C).
 - **The symptoms of hyperthermia:** The symptoms of hyperthermia include an increase in the internal temperature of the body, dizziness, lethargy, drowsiness, and fainting.
 - **The effects of hyperthermia:** Failure to perceive heat. Failure to recognize the need to exit the room. Unawareness of impending hazard. Fetal damage to pregnant women. Physical inability to exit the room. Unconsciousness.



WARNING: The use of alcohol, drugs, or medication may lead fatal hyperthermia.

- E) Without authorization from the local electrical inspection institution, any modification to the sauna room is illegal.
- F) Warning: To avoid electric shock or burns, do not operate the sauna room unless heating safety guard is properly installed.
- G) Do not take any flammable materials into sauna room at any time to avoid fire.
- H) Other safety warning:
 - a) Exit immediately when feels uncomfortable, dizzy, or sleepy if stay in the sauna room too long time.
 - b) Supervise children and retarded persons when they are using sauna room at all times.
 - c) Pregnant woman, who in poor health or under medical care should follow the doctor's advice before using the sauna room.
 - d) Using sauna room will cause unconsciousness if over drunk or over taken medicines.
 - e) Please contact maintenance person if sauna room has problems
 - f) Disconnect sauna room power supply from wall socket before maintaining.

THE MANUAL MUST BE KEPT AVAILABLE FOR FUTURE MAINTENANCE.

Installation

1. Installation requirements

- a. Do not plug any other appliances into the outlet with your traditional sauna.
- b. Install the sauna on a completely level floor.
- c. Do not spray the exterior with water. If the floor is damp, install a floor separator to keep the sauna high & dry.
- d. Do not store flammable objects or chemical substances near the sauna .

Installation procedure

Sauna Room:

1. Structure of Infrared Sauna. **See FIG-1.**

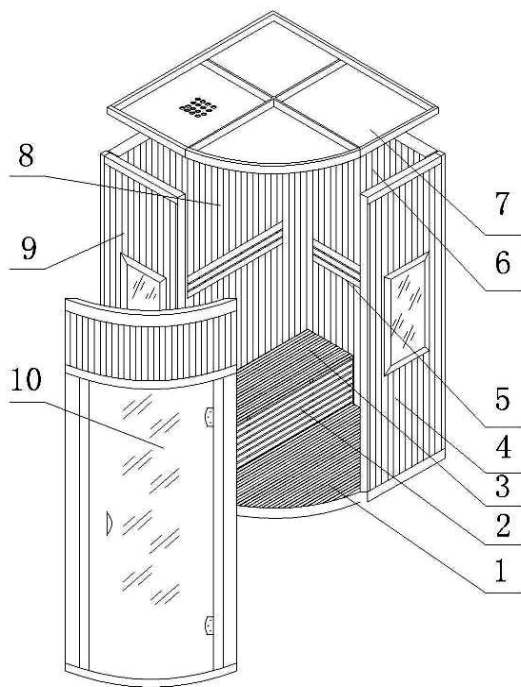

FIG-1

- | | | | | |
|---------------------|-------------------|--------------------|----------------------|-----------------|
| 1. Bottom board | 2. sitting baffle | 3. sitting board | 4. right front board | 5. back rest |
| 6. right back board | 7. top board | 8. left back board | 9. left front board | 10. front board |

**Total packed in 6 cartons.
See FIG-2**

Installation Steps:



FIG-2 cartons

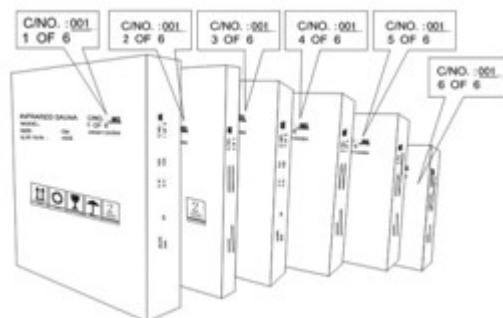

FIG-2.1 C/No.

Check the C/NO. on both cartons if they are the same. If not, please notify the store/website you purchased your Infrared Sauna, for example: C/NO: 002 1 OF 3, C/NO: 002 2 OF 3 and C/NO: 002 3 OF 3 are for one unit. See **FIG-2.1**

3. Make sure all parts are present before installing the unit. See packing list below.:

- | | | | |
|--------------------|---------------------|---------------------|----------------------|
| A. user manual | B. front board | C. left front board | D. right front board |
| E. sitting baffle | F. bottom board | G. sitting board | H. backrest |
| I. left back board | J. right back board | K. top board | |

4. Place the bottom board in the desired location of your sauna. See FIG-3.

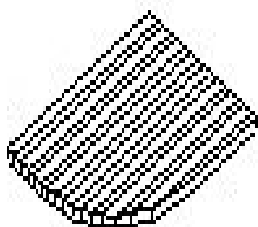

FIG-3 Placing bottom floor

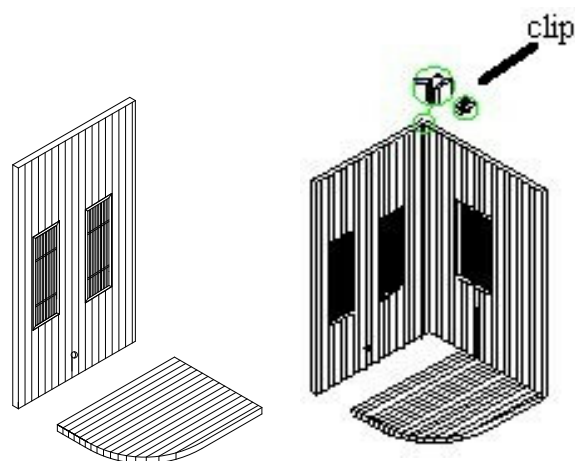

FIG-4 Assembling left and right back board

5. Align corresponding battens of the left and right back board, make sure the protruding batten aim to the flute, then lock the clips. See FIG-4

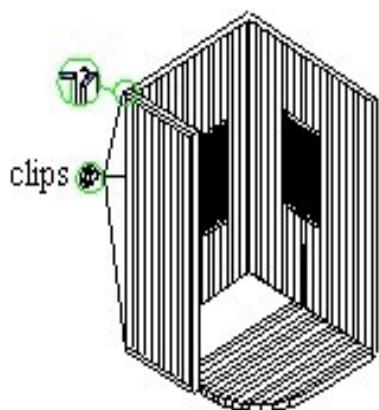

FIG-5 Assembling left front board

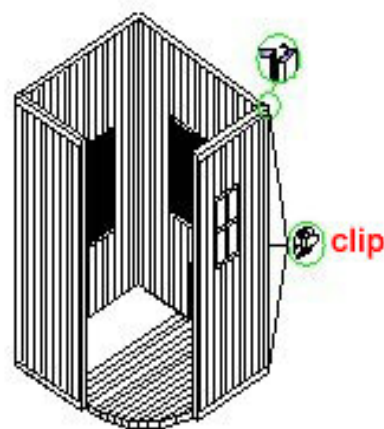

FIG-6 Assembling right front board

6. Align the corresponding battens of left front board and left back board, make sure they are fit with

each other, and lock the clips.. **See FIG- 5.**

7.Align the corresponding battens of right front board and right back board, make sure they are fit with each other, and lock the clips.. **See FIG-6.**

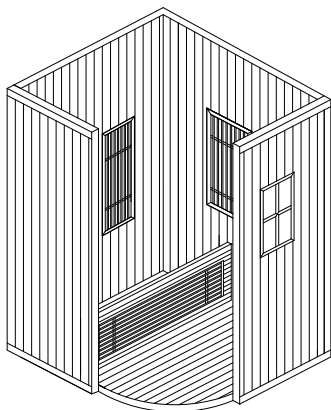

FIG-7 Assembling sitting baffle and board

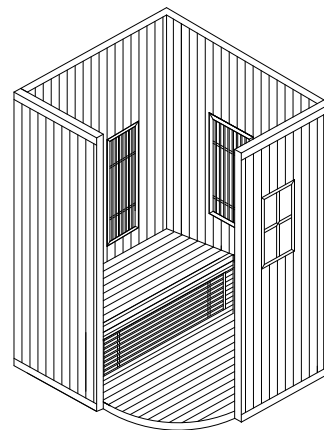

FIG-8 Assembling sitting board

8.Hold the left front board and right back board along the slot, then place the sitting baffle vertically into the slots and make sure the two legs are upright, **See FIG- 7,**Then Place the sitting board.lock them tight with screws. Note: make sure the sitting baffle uprights to sitting board. **See FIG- 8.**

Next, connect the bench's heater element wire to corresponding wire from the back wall.**See FIG-11**
Note: Make sure the wires are connected tightly, otherwise the heater will not work.

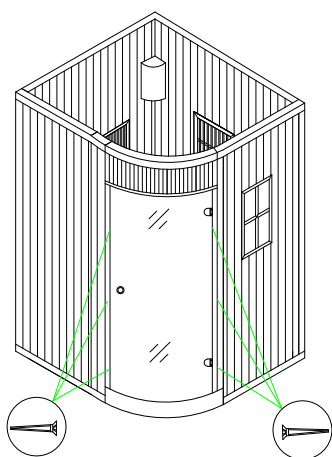

FIG-9 Assembling front board

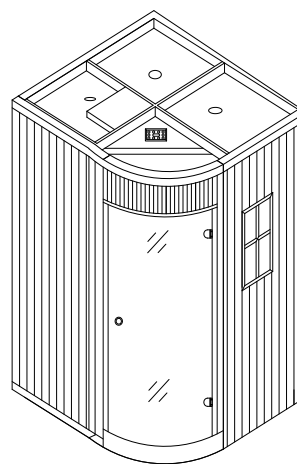

FIG-10 Assembling the top board

9.Align the corresponding battens of left front board and right front board, make sure they are fit with each other, and lock the screw.**See FIG-9.**

10. Deploy the top board flat., Raise the top board high enough to see if it fits with the surrounding boards, (When put down the top board, make sure the wires slipped through the corresponding holes of the top board.) and then put down. **See FIG-10.**

Connect all the wires and connectors to the corresponding outlets on the top board. Please be sure all the plugs are connected tightly. **See FIG-11**

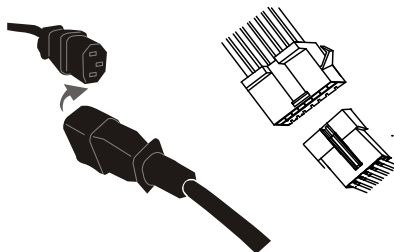

FIG-11 Connect the wire for infrared heater.

11. Assembling the light, Fix the lampholder with screws, and connect the power supply lines. **See FIG-12.** Then lock the lamp and glass cover tight. , then lock it with screw. **See FIG-12**



FIG-12 Assembling the light



FIG-13 Install the lampshade

12. Put the lampshade under the glass cover (be moderate), then lock it with screw. **See FIG-13**



FIG-14 install the warm barothermohygrogram



FIG-15 examine the stove

13. Take out the warm barothermohygrogram, and put it on the level of panel. Note: do not put the warm barothermohygrogram under the heat stove. **See FIG-14**

14. Take out the sauna heat stove, and examine the equipment. **See FIG-15.**



FIG-16 disassemble the wooden frame



FIG-17 connect the power supply line of stove

15. Build the heater frame, Disassemble one side batten of the wooden support frame, then lock it with screw. **See FIG-15**

16. After that, upend the sauna stove into the wooden frame, and disassemble the right aluminum board, then connect the power supply line of the sauna stove. (Note: reference stove manual) Keep the power supply line away stove and lock them tight with screws. **See FIG-17**



FIG-18 location of the stove



FIG-19 Place sauna stone

17. After assembling the wires, install the right aluminum board and wooden batten, and place the stove on the right location. **See FIG-18**

18. Place sauna stone. Put bigger stones on the bottom and smaller stones on the upper. Also can not be too tight in order to facilitate the air circulation. And fix the baffle. **See FIG-19**

Operation for steam sauna:

1. Precautions

- Check all the circuitry and the plug meet all requirements.
- Set the temperature and time to a comfortable level, normally, 60 minutes at about 80°C.
- Drink a cup of water before the sauna session.
- After 2 hours of continuous use, shut the sauna down for one hour.
- To avoid burns, do not touch the heating element.

2. Operation sauna stove:

- Plug the sauna into a outlet which is stated in nameplate. Do not share the outlet with any other appliances. Plug the unit into the outlet and use the ON/OFF switch to activate the sauna on sauna stove. Sauna should be unplugged when not in use.
- Turn the temperature button on the outer controller to set the temperature.
- Turn the 'time' button to set the using time.
- After your sauna session, turn off, and unplug the power cable.
- See the user manual of sauna stove to use it.

3. Operation Infrared Display

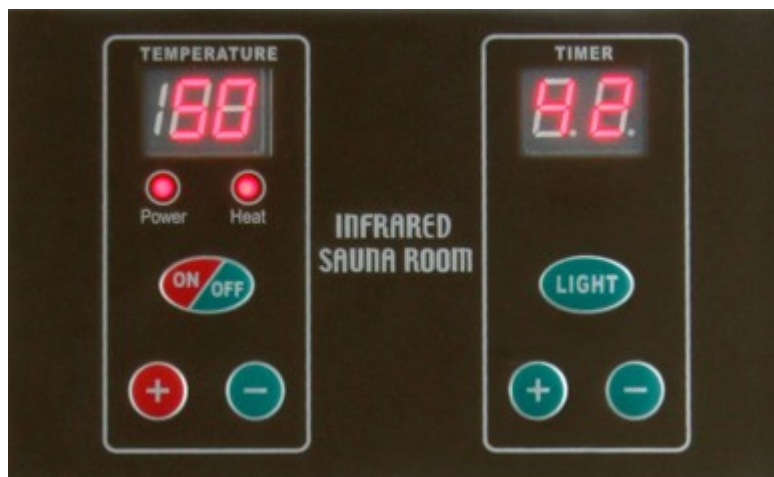

- a) Check if the voltage is suitable for the sauna room
- b) Plug the sauna room to the socket (Note: Do not share the socket with any other electric appliances.)
- c) Press the 'ON/OFF' button on control panel to start the sauna room. (Note: The Sauna room should be **unplugged** when it is not in use for a long time.)
- d) Turn ON/OFF button on control panel for the light.
- e) Set the sauna temperature and time through control panel, normally, 60 minutes at 120°F or 49°C
- f) Let the sauna to be preheated for a while before go into the sauna room
- g) To use the sauna room (Note: When sauna is preheated to a temperature of 42°C/107.6°F, you can then go into the sauna room and enjoy it, it is much better if you can have a cup of water before sauna)
- h) Other operation hints
 - ◇ Press the 'temperature' button '+', '-' to set the temperature. Press '+' button one time, the temperature will raise 1°C. If being pressed longer such as three seconds, the temperature will be set rapidly. Decrease the temperature in the same way but by pressing '-' button. If want to adjust the temperature again during sauna, you will have to turn off the display by pressing turn on/off button to set new temperature.
 - ◇ Press the 'time' button '+', '-' to set sauna time. The operation method is the same as above. When the display time in the digital control panel reaches '05', the buzzer will beep for 1 minute to inform you it will stop work 5 minutes later.
 - ◇ when the temperature inside the sauna room reaches the set temperature, or the time reaches the set time, the "heat" light will be off and all the heaters will stop working.

Trouble Shooting:**Steam function:**

	problem	possible reason	countermeasure
1	indicator light for power supply not working	The connector is not connected properly	Check the connector or replace a new one
		No power supply input	check the circuitry
		Indicator light is broken	replace the outer controller
2	Sauna stove is not heating up	The heater is broken	Replace with a new one Of the same specifications
		The wire junction or the heater's wire is loosen	Check and make them tight
3	Odor from the sauna	The circuit's problems	1) there is eye winker around, remove it 2) parts on the circuit is broken
4	Light bulb is not working	Light bulb is burned out	Replace the light bulb
		Lamp holder is broken	Replace the lamp holder

	PROBLEM	Possible Causes	SOLUTION
1	“Power” indicator light not on	The connector is not connected properly	Check the 7-pin connector or replace a new one
		No power supply input	check the circuitry (especially check if the power supply is turned on)
		Indicator light is defected	Replace the relative PCB.
2	“Heat” Indicator light not on	The light is defected	Replace the relative PCB.
		The PCB panel is defected	Replace the relative PCB.
		the temperature sensor is defected	check if the connection is loosen or replace it
3	Infrared Heater not heating up	The heater is broken	Replace with a new one Of the same specifications
		The wire junction or the heater’s wire is loosen	Check and make them tight
		the temperature sensor is broken	check junction of the temperature if the sensor is loosen or replace it
		the fuse in control box is broken	replace it with a new fuse
		the circuit panel of the relay is not work	replace the circuit panel
4	Peculiar smell from the sauna	1) there is something around the heaters	remove it
		2) some heater’s temperature is over high,	Cut off the power supply and replace it
		3)Some parts on the PCB is burnt to broken	replace it with a new PCB
5	Sauna room not work	Power cord is unplug	Plug back power cord to outlet
		Outlet has no power	Check outlet or circuit breaker
		The switch power or PCB has problem	Replace the switch power or related PCB
6	Temperature display show “EP”	The connector of temperature sensor is loose or sensor damaged	Tighten the connector of temperature sensor or change a new temperature sensor.
7	Temperature display show “H”	The temperature inside the sauna room is too high	Turn off the unit, and contact the manufacture.

Cleaning

Clean the outer controller with a wet towel, or clean with a small amount of hand-soap mixed with warm water if necessary. Clean the sauna room with a wet cotton towel, dry with a clean dry towel. **Do not use benzene, alcohol, or strong cleaning chemicals on sauna. NOTE: Any chemical that can damage wood material will damage the sauna and the protection layer that is on the wood.**

***** Do not leave the sauna on for more than 2 hours at a time. *****

Transportation and storage

1. Avoid exposure to rain, snow or strong collisions during transport.
2. Do not store in damp environments.

Packing list

Name	Qty	Confirmation	Name	Qty	Confirmation
Front board	1pc		Sitting baffle	1pc	
Left front board	1pc		Sauna Stove	1pc	
Right front board	1pc		Sauna stone	1pc	
Right back board	1pc		barothermohygrogram	1pc	
Left back board	1pc		Light	1pc	
Bottom board	1pc		Screw , bolt	1bag	
Top board	1pc		Spare parts cartons	2ctns	
Sitting board	1pc		User manual	1pc	

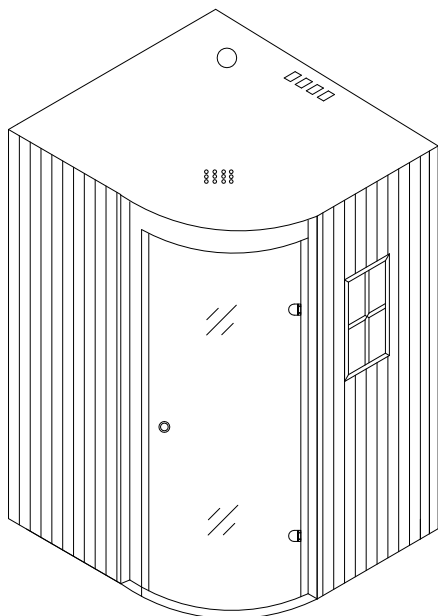

SIZE: 125*110*57*190cm
 VOLTAGE: 110-120Vac
 220-240Vac
 POWER: 1800W+3000W